



EMC TEST REPORT For RCM

Test Report No. : KES-EM-20T0364
Date of Issue : Jun. 18, 2020
Product name : NETWORK CAMERA
Model/Type No. : XNP-6400RW
Variant Model : -
Applicant : Hanwha Techwin Co., Ltd.
Applicant Address : 6, Pangyo-ro 319Beon-gil, Bundang-gu, Seongnam-si,
Gyeonggi-do, Republic of Korea
Manufacturer : 1. HANWHA TECHWIN SECURITY VIETNAM CO.,LTD.
2. D-TECH CO.,LTD.
Manufacturer Address : 1. Lot O-2, Que Vo Industrial Zone extended area,
Nam Son commune, Bac Ninh city, Bac Ninh province, Vietnam
2. 173-25, Saneop-ro, Gwonseon-gu, Suwon-si, Gyeonggi- do,
Korea (Suwon Industrial Complex)
Date of Receipt : Jun. 05, 2020
Test date : Jun. 12, 2020 ~ Jun. 13, 2020
Test Results : In Compliance Not in Compliance

Tested by

Min Seong, Kim
EMC Test Engineer

Reviewed by

Dong-Hun, Jang
EMC Technical Manager

This test report is not related to KS Q ISO/IEC 17025 and KOLAS.

This report shall not be reproduced except in full, without the written approval of KES Co., Ltd.
The results shown in this test report refer only to the sample(s) tested unless otherwise stated.
The authenticity of the test report, contact shchoi@kes.co.kr



KES Co., Ltd.

3701, 40, Simin-daero 365beon-gil,
Dongan-gu, Anyang-si, Gyeonggi-do, 14057, Korea
Tel: +82-31-425-6200 / Fax: +82-31-424-0450
www.kes.co.kr

Report No.:
KES-EM-20T0364
Page (2) of (36)

REPORT REVISION HISTORY

Date	Test Report No.	Revision History
Jun. 18, 2020	KES-EM-20T0364	Issued

This report shall not be reproduced except in full, without the written approval of KES Co., Ltd. This document may be altered or revised by KES Co., Ltd. personnel only, and shall be noted in the revision section of the document. Any alteration of this document not carried out by KES Co., Ltd. will constitute fraud and shall nullify the document.

This report shall not be reproduced except in full, without the written approval of KES Co., Ltd.
The results shown in this test report refer only to the sample(s) tested unless otherwise stated.
The authenticity of the test report, contact shchoi@kes.co.kr



TABLE OF CONTENTS

1.0	General Product Description.....	4
1.1	Test Voltage & Frequency	6
1.2	Variant Model Differences.....	6
1.3	Device Modifications	6
1.4	Equipment Under Test.....	6
1.5	Support Equipments	6
1.6	External I/O Cabling	7
1.7	EUT Operating Mode(s)	7
1.8	Configuration.....	8
1.9	Remarks when standards applied	9
1.10	Calibration Details of Equipment Used for Measurement	9
1.11	Test Facility	9
1.12	Laboratory Accreditations and Listings	9
2.0	Test Regulations.....	10
2.1	Conducted Emissions at Mains Power Ports	12
2.2	Conducted Emissions at Telecommunication Ports.....	13
2.3	Radiated Electric Field Emissions(Below 1 GHz)	14
2.4	Radiated Electric Field Emissions(Above 1 GHz)	15
APPENDIX A – TEST DATA.....		16
	Conducted Emissions at Mains Power Ports.....	16
	Conducted Emissions at Telecommunication Ports	18
	Radiated Electric Field Emissions(Below 1 GHz)	19
	Radiated Electric Field Emissions(Above 1 GHz).....	20
	Test Setup Photos and Configuration	21
	Conducted Emissions at Mains Power Ports.....	21
	Conducted Emissions at Telecommunication Ports	22
	Radiated Electric Field Emissions(Below 1 GHz)	23
	Radiated Electric Field Emissions(Above 1 GHz).....	24
	EUT External Photographs.....	25
	EUT Internal Photographs	26



1.0 General Product Description

Main Specifications of EUT are:

Video	
Imaging Device	1/2.8" 2MP CMOS
Effective Pixels	1944(H)x1212(V)
Min. Illumination	Color: 0.05Lux(F1.6, 1/30sec) BW: 0Lux(IR LED On)
Video Out	None
Lens	
Focal Length (Zoom Ratio)	4.25~170mm(40x) zoom
Max. Aperture Ratio	F1.6(Wide)~F4.95(Tele)
Angular Field of View	H: 65.66°(Wide)~1.88°(Tele) / V: 39.40°(Wide)~1.09°(Tele)
Min. Object Distance	Wide: 1.5m(4.92ft), Tele: 3m(9.84ft)
Focus Control	Oneshot AF, Focus save
Lens Type	DC auto iris
Pan / Tilt / Rotate	
Pan Range	360° Endless
Pan Speed	Max. 500°/sec, Manual: 0.024°/sec~250°/sec
Tilt Range	110°(-20°~90°)
Tilt Speed	Max. 350°/sec, Manual: 0.024°/sec~250°/sec
Sequence	Preset(300ea), Swing, Group(6ea), Trace, Tour, Auto Run, Schedule, Preset trace recording
Preset Accuracy	±0.1°
Azimuth	Support
Auto Tracking	Object auto tracking(Person/Vehicle)
Operational	
IR Viewable Length	300m(984.25ft)
Camera Title	Displayed up to 85 characters, Direction Indicator
Day & Night	Auto(ICR)/Color/BW/Schedule
Backlight Compensation	BLC, HLC, WDR
Wide Dynamic Range	150 dB
Digital Noise Reduction	SSNRV
Digital Image Stabilization	Support(built-in gyro sensor)
Defog	Support
Motion Detection	8ea, 8point polygonal zones
Privacy Masking	32ea, rectangular Support - Color: Grey/Green/Red/Blue/Black/White - Mosaic
Gain Control	Low / Middle / High
White Balance	ATW / AWC / Manual / Indoor / Outdoor
LDC	None
Electronic Shutter Speed	Minimum / Maximum / Anti flicker (2~1/12,000sec)
Video Rotation	Flip, Mirror
Analytics	Directional detection, Fog detection, Face detection, Motion detection, Appear/Disappear, Enter/Exit, Loitering, Tampering, Virtual line, Shock detection * Audio detection, Sound classification(with NW I/O Box)
Business Intelligence	None
Serial Interface	None
Alarm I/O	None
Alarm Triggers	Analytics, Network disconnect * Alarm input(with NW I/O Box)
Alarm Events	File upload via FTP and e-mail Notification via e-mail SD/SDHC/SDXC or NAS recording at event triggers PTZ Preset * Alarm output(with NW I/O Box)
Audio In	None
Audio Out	None
Wiper	Support

This report shall not be reproduced except in full, without the written approval of KES Co., Ltd.
The results shown in this test report refer only to the sample(s) tested unless otherwise stated.
The authenticity of the test report, contact shchoi@kes.co.kr



KES Co., Ltd.

3701, 40, Simin-daero 365beon-gil,
 Dongan-gu, Anyang-si, Gyeonggi-do, 14057, Korea
 Tel: +82-31-425-6200 / Fax: +82-31-424-0450
 www.kes.co.kr

Report No.:
 KES-EM-20T0364
 Page (5) of (36)

Network	
Ethernet	RJ-45(10/100BASE-T)
Video Compression	H.265/H.264,MJPEG
Resolution	1920x1080, 1280x1024, 1280x960, 1280x720, 1024x768, 800x600, 800x448, 720x576, 720x480, 640x480, 640x360, 320x240
Max. Framerate	H.265/H.264: Max. 60fps/50fps(60Hz/50Hz) MJPEG: Max. 30fps/25fps(60Hz/50Hz)
Smart Codec	Manual(5ea area), WiseStreamII
Video Quality Adjustment	H.264/H.265: Target bitrate level control MJPEG: Target bitrate level control
Bitrate Control	H.264/H.265: CBR or VBR MJPEG: VBR
Streaming	Unicast(20 users) / Multicast (128 user) Multiple streaming(Up to 10 profiles)
Audio Compression	None
Protocol	IPv4, IPv6, TCP/IP, UDP/IP, RTP(UDP), RTP(TCP), RTCP,RTSP, NTP, HTTP, HTTPS, SSL/TLS, DHCP, FTP, SMTP, ICMP, IGMP, SNMPv1/v2c/v3(MIB-2), ARP, DNS, DDNS, QoS, PIM-SM, UPnP, Bonjour,LLDP, SRTP
Security	HTTPS(SSL) Login Authentication Digest Login Authentication IP Address Filtering User access log 802.1X Authentication(EAP-TLS, EAP-LEAP) Device certificate(Hanwha Techwin Root CA)
Edge Storage	Micro SD/SDHC/SDXC 2slot 1TB
Application Programming Interface	ONVIF Profile S/G/T SUNAPI(HTTP API) Wisenet open platform
Webpage Language	English, Korean, Chinese, French, Italian, Spanish, German, Japanese, Russian, Swedish, Portuguese, Czech, Polish, Turkish, Dutch, Hungarian, Greek
Web Viewer	Supported OS: Windows 7, 8.1, 10, Mac OS X 10.10, 10.11, 10.12 Recommended Browser: Google Chrome Supported Browser: MS Explore11, MS Edge, Mozilla Firefox(Window 64bit only), Apple Safari(Mac OS X only)
Memory	4GB RAM, 512MB Flash
Environmental	
Operating Temperature / Humidity (TBD)	-40°C~+60°C (-40°F ~ +140°F) / Less than 95% RH(Non-condensing) Maximum Temperature : +60°C(+140°F), □ □ □ within 8 hours Absolute maximum(According to NEMA TS2, 2.2.7):+74°C → TBD
Storage Temperature / Humidity	-50°C~+60°C (-58°F~+140°F) / Less than 95% RH(Non-condensing)
Certification	IP66, IK10(Camera body only→TBD), NEMA4X
Electrical	
Input Voltage(TBD)	HPoE(IEEE802.3bt, Class7, Type4). TBD(Power Class)
Power Consumption(TBD)	Typ.20W, Max.35W Camera only
Mechanical	
Color / Material	White, Black / Aluminum + Polycarbonate + ASA (Sun shield) + Tempered glass (Window)
RAL Code	White : RAL 9003 / Black : RAL 9005
Product dimensions / weight	∅184.9 x 318.8mm / 5.4Kg
Conduit hole	None
Hanging mount(Dome)	None
Skin cover(Dome)	None
Weather cap(Dome)	None
Power module	None
Backbox	None

This report shall not be reproduced except in full, without the written approval of KES Co., Ltd.
 The results shown in this test report refer only to the sample(s) tested unless otherwise stated.
 The authenticity of the test report, contact shchoi@kes.co.kr



KES Co., Ltd.

3701, 40, Simin-daero 365beon-gil,
Dongan-gu, Anyang-si, Gyeonggi-do, 14057, Korea
Tel: +82-31-425-6200 / Fax: +82-31-424-0450
www.kes.co.kr

Report No.:
KES-EM-20T0364
Page (6) of (36)

1.1 Test Voltage & Frequency

Unless indicated otherwise on the individual data sheet or test results, the test voltage and frequency was as indicated below.

Voltage 240 Vac 100 Vac 24 Vac 12 Vdc PoE

Frequency 50 Hz 60 Hz Hz

1.2 Variant Model Differences

Not applicable

1.3 Device Modifications

Not applicable

1.4 Equipment Under Test

Description	Model Number	Serial Number	Manufacturer	Remarks
NETWORK CAMERA	XNP-6400RW	-	HANWHA TECHWIN SECURITY VIETNAM CO.,LTD.	EUT
Fiber PoE Injector	PT-PSE109GBRO-AH-S	-	Dongguan PROCET Network Technology Co.,Ltd	EUT

1.5 Support Equipments

Description	Model Number	Serial Number	Manufacturer	Remarks
Notebook 1	P95G001	8KM8HT2	Wistron Infocom (Chengdu) Company Limited	-
Notebook 1 Adapter	LA65NS2-01	-	LITE-ON TECHNOLOGY (CHANGZHOU)CO.,LTD.	-
Micro SD Card	-	-	SanDisk	8 GB
PoE Switch	GS728TPP	-	NETGEAR	-
Notebook 2	LG15N54	410NZGK015231	LG Electronics Co., Ltd.	-
Notebook 2 Adapter	ADP-90WH B	84ZW19F1663	DELTA ELECTRONICS (JIANGSU) LTD.	-

This report shall not be reproduced except in full, without the written approval of KES Co., Ltd.
The results shown in this test report refer only to the sample(s) tested unless otherwise stated.
The authenticity of the test report, contact shchoi@kes.co.kr



1.6 External I/O Cabling

Start		END		Cable Spec.	
Description	I/O Port	Description	I/O Port	Length	Shield
NETWORK CAMERA (EUT)	RJ-45	Fiber PoE Injector (EUT)	PoE	1.0	S
	SLOT	Micro SD Card	SLOT	-	-
Fiber PoE Injector (EUT)	LAN	Notebook 1	RJ-45	3.0	S
	SFP	PoE Switch	SFP	10.0	U
PoE Switch	LAN	Notebook 2	RJ-45	1.0	S

* Unshielded=U, Shielded=S

1.7 EUT Operating Mode(s)

Test mode	operating
Operation mode	checked that the camera video output was working properly in the web viewer and used the ping test to verify that the network behavior was working properly.

EUT Test operating S/W		
Name	Version	Manufacture Company
Web Viewer	-	-

This report shall not be reproduced except in full, without the written approval of KES Co., Ltd.
 The results shown in this test report refer only to the sample(s) tested unless otherwise stated.
 The authenticity of the test report, contact shchoi@kes.co.kr

1.8 Configuration

■ AC Main
□ DC Main

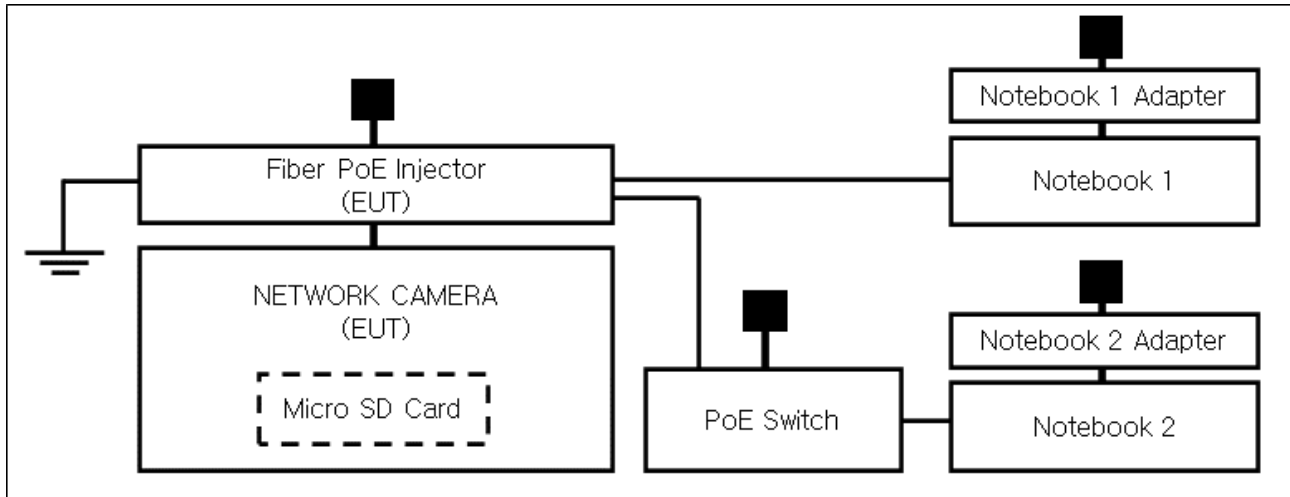

This report shall not be reproduced except in full, without the written approval of KES Co., Ltd.
The results shown in this test report refer only to the sample(s) tested unless otherwise stated.
The authenticity of the test report, contact shchoi@kes.co.kr

1.9 Remarks when standards applied

N/A







1.10 Calibration Details of Equipment Used for Measurement

Test equipment and test accessories are calibrated on regular basis. The maximum time between calibrations is one year or what is recommended by the manufacturer, whichever is less.

1.11 Test Facility

The measurement facility is located at 473-21 Gayeo-ro, Yeosu-si, Gyeonggi-do, 12658, Korea. The sites are constructed in conformance with the requirements of ANSI C63.4:2014 and CISPR 16-1-4:2012

1.12 Laboratory Accreditations and Listings

Country	Agency	Scope of Accreditation	Logo
KOREA	RRA	EMI (3 m & 10 m Semi-Anechoic Chamber , 10 m Open Area and conducted test site) EMS (ESD, RS, EFT/Burst, Surge, CS, Magnetic, Dips and interruptions)	 KR0100
International	KOLAS	EMI (3 m & 10 m Semi-Anechoic Chamber , and conducted test site) EMS (ESD, RS, EFT/Burst, Surge, CS, Magnetic, Dips and interruptions)	 KT489
USA	FCC	3 m & 10 m Semi-Anechoic Chamber, 10 m Open Area and Conducted test site to perform FCC Part 15/18 measurements.	 KR0100
Canada	ISED	3 m & 10 m Semi-Anechoic Chamber and Conducted test site	 23298-1
JAPAN	VCCI	Mains Ports Conducted Interference Measurement, Telecommunication Ports Conducted Disturbance Measurement and Radiation 10 meter site, Facility for measuring radiated disturbance above 1 GHz	 R-20056, C-20036, T-20040, G-20057
Europe	TÜ V SÜ D	EMI (3 m & 10 m Semi-Anechoic Chamber , 10 m Open Area and conducted test site) EMS (ESD, RS, EFT/Burst, Surge, CS, Magnetic, Dips and interruptions)	 CARAT 001633 0003

This report shall not be reproduced except in full, without the written approval of KES Co., Ltd.
 The results shown in this test report refer only to the sample(s) tested unless otherwise stated.
 The authenticity of the test report, contact shchoi@kes.co.kr

2.0 Test Regulations

The emissions tests were performed according to following regulations:

- EMC – Directive 2014/30/EU

- EN 61000-6-3: 2011
- EN 61000-6-1: 2007
- EN 61000-6-4: 2007 +A1: 2011
- EN 61000-6-2: 2005
- EN 55011: 2007 +A1: 2010 Group 1 Group 2
 Class A Class B
- EN 55014-1: 2006 +A2: 2011
- EN 55014-2: 1997 +A2: 2008
- EN 55015: 2013
- EN 55032: 2015 Class A Class B
- EN 55024: 2010
- EN 50130-4: 2011 +A1: 2014
- EN 61000-3-2: 2014
- EN 61000-3-3: 2013
- EN 61326-1: 2013



KES Co., Ltd.

3701, 40, Simin-daero 365beon-gil,
Dongan-gu, Anyang-si, Gyeonggi-do, 14057, Korea
Tel: +82-31-425-6200 / Fax: +82-31-424-0450
www.kes.co.kr

Report No.:
KES-EM-20T0364
Page (11) of (36)

-
- | | | |
|---|---|----------------------------------|
| <input type="checkbox"/> VCCI -CISPR 32:2016 | <input type="checkbox"/> Class A | <input type="checkbox"/> Class B |
| <input checked="" type="checkbox"/> AS/NZS CISPR32:2015 | <input checked="" type="checkbox"/> Class A | <input type="checkbox"/> Class B |
| <input type="checkbox"/> 47 CFR Part 15, Subpart B | | |
| <input type="checkbox"/> CISPR 22:2009 +A1:2010 | <input type="checkbox"/> Class A | <input type="checkbox"/> Class B |
| <input type="checkbox"/> ANSI C63.4-2009 | | |
| <input type="checkbox"/> IC Regulation ICES-003 : 2016 | | |
| <input type="checkbox"/> CAN/CSA CISPR 22-10 | <input type="checkbox"/> Class A | <input type="checkbox"/> Class B |
| <input type="checkbox"/> ANSI C63.4-2014 | | |
| <input type="checkbox"/> RE- Directive 2014/53/EU | | |
| <input type="checkbox"/> EN 301 489-1 V1.9.2 | | |
| <input type="checkbox"/> Equipment for fixed use | | |
| <input type="checkbox"/> Equipment for vehicular use | | |
| <input type="checkbox"/> Equipment for portable use | | |
| <input type="checkbox"/> EN 301 489-3 V1.6.1 | | |
| <input type="checkbox"/> EN 301 489-17 V2.2.1 | | |
| <input type="checkbox"/> EN 60945:2002 | | |

This report shall not be reproduced except in full, without the written approval of KES Co., Ltd.
The results shown in this test report refer only to the sample(s) tested unless otherwise stated.
The authenticity of the test report, contact shchoi@kes.co.kr



KES Co., Ltd.

3701, 40, Simin-daero 365beon-gil,
Dongan-gu, Anyang-si, Gyeonggi-do, 14057, Korea
Tel: +82-31-425-6200 / Fax: +82-31-424-0450
www.kes.co.kr

Report No.:
KES-EM-20T0364
Page (12) of (36)

2.1 Conducted Emissions at Mains Power Ports

Test Date
Jun. 12, 2020

Test Location
Electro wave Shieldroom #6

Test Equipment

Used	Description	Model Number	Manufacturer	Serial Number	Cal. Due
<input checked="" type="checkbox"/>	EMI Test S/W	EMC32	R & S	9.12.00	-
<input checked="" type="checkbox"/>	EMI TEST RECEIVER	ESR3	R & S	101783	01, 20, 2021
<input checked="" type="checkbox"/>	LISN	ENV216	R & S	101787	01, 02, 2021
<input checked="" type="checkbox"/>	LISN	ESH2-Z5	R & S	100450	01, 02, 2021
<input checked="" type="checkbox"/>	PULSE LIMITER	ESH3-Z2	R & S	101915	01, 02, 2021

Test Conditions

Temperature: 23,5 °C
Relative Humidity: 48,1 % R.H.

Frequency Range of Measurement

150 kHz to 30 MHz

Instrument Settings

IF Band Width: 9 kHz

Test Results

The requirements are:

- PASS
- NOT PASS
- NOT APPLICABLE

Remarks

See Appendix A for test data.

This report shall not be reproduced except in full, without the written approval of KES Co., Ltd.
The results shown in this test report refer only to the sample(s) tested unless otherwise stated.
The authenticity of the test report, contact shchoi@kes.co.kr



2.2 Conducted Emissions at Telecommunication Ports

Test Date
Jun. 12 2020

Test Location
Electro wave Shieldroom #6

Test Equipment

Used	Description	Model Number	Manufacturer	Serial Number	Cal. Due
<input checked="" type="checkbox"/>	EMI Test S/W	EMC32	R & S	9.12.00	-
<input checked="" type="checkbox"/>	EMI TEST RECEIVER	ESR3	R & S	101783	01, 20, 2021
<input checked="" type="checkbox"/>	LISN	ENV216	R & S	101787	01, 02, 2021
<input checked="" type="checkbox"/>	LISN	ESH2-Z5	R & S	100450	01, 02, 2021
<input checked="" type="checkbox"/>	PULSE LIMITER	ESH3-Z2	R & S	101915	01, 02, 2021
<input type="checkbox"/>	8-WIRE ISN CAT3,5	ENY81	R & S	100174	01, 07, 2021
<input type="checkbox"/>	8-WIRE ISN CAT6	ENY81-CAT6	R & S	101665	01, 07, 2021
<input checked="" type="checkbox"/>	ISN	ISN S8	SCHWARZBECK	ISN-S8-0019	03, 10, 2021
<input type="checkbox"/>	CDN	CDNS502A	TESEQ	40431	01, 02, 2021

Test Conditions

Temperature: 23,5 °C
Relative Humidity: 48,1 % R.H.

Frequency Range of Measurement

150 kHz to 30 MHz

Instrument Settings

IF Band Width: 9 kHz

Test Results

The requirements are:

- PASS
- NOT PASS
- NOT APPLICABLE

Remarks

See Appendix A for test data.

This report shall not be reproduced except in full, without the written approval of KES Co., Ltd.
The results shown in this test report refer only to the sample(s) tested unless otherwise stated.
The authenticity of the test report, contact shchoi@kes.co.kr



KES Co., Ltd.

3701, 40, Simin-daero 365beon-gil,
Dongan-gu, Anyang-si, Gyeonggi-do, 14057, Korea
Tel: +82-31-425-6200 / Fax: +82-31-424-0450
www.kes.co.kr

Report No.:
KES-EM-20T0364
Page (14) of (36)

2.3 Radiated Electric Field Emissions(Below 1 GHz)

Test Date
Jun. 12, 2020

Test Location
 OPEN AREA TEST SITE #2 SEMI ANECHOIC CHAMBER #4(10 m)

Test Equipment

Used	Description	Model Number	Manufacturer	Serial Number	Cal. Due
<input checked="" type="checkbox"/>	EMI Test S/W	EP5/RE	TOYO Corporation	6.0.0	-
<input checked="" type="checkbox"/>	EMI TEST RECEIVER	ESU26	R & S	100551	04, 01, 2021
<input checked="" type="checkbox"/>	AMPLIFIER	SCU 01	R & S	100603	11, 25, 2020
<input checked="" type="checkbox"/>	TRILOG-BROADBAND ANTENNA	VULB9163	Schwarzbeck	715	11, 29, 2020
<input checked="" type="checkbox"/>	ATTENUATOR	8491A	HP	32173	03, 10, 2021

Test Conditions
Temperature: 23,5 °C
Relative Humidity: 48,9 % R.H.

Frequency Range of Measurement
30 MHz to 1 GHz

Instrument Settings
IF Band Width: 120 kHz

Test Results
The requirements are:

- PASS
- NOT PASS
- NOT APPLICABLE

Remarks
See Appendix A for test data.

This report shall not be reproduced except in full, without the written approval of KES Co., Ltd.
The results shown in this test report refer only to the sample(s) tested unless otherwise stated.
The authenticity of the test report, contact shchoi@kes.co.kr



KES Co., Ltd.

3701, 40, Simin-daero 365beon-gil,
Dongan-gu, Anyang-si, Gyeonggi-do, 14057, Korea
Tel: +82-31-425-6200 / Fax: +82-31-424-0450
www.kes.co.kr

Report No.:
KES-EM-20T0364
Page (15) of (36)

2.4 Radiated Electric Field Emissions(Above 1 GHz)

Test Date
Jun. 13, 2020

Test Location
SEMI ANECHOIC CHAMBER #3

Test Equipment

Used	Description	Model Number	Manufacturer	Serial Number	Cal. Due
<input checked="" type="checkbox"/>	EMI Test S/W	EP5/RE	TOYO Corporation	6.0.0	-
<input checked="" type="checkbox"/>	EMI TEST RECEIVER	ESR7	R & S	101190	08, 06, 2020
<input checked="" type="checkbox"/>	PREAMPLIFIER	8449B	AGILENT	3008A01967	04, 20, 2021
<input type="checkbox"/>	ATTENUATOR	8491A	HP	35496	03, 10, 2021
<input checked="" type="checkbox"/>	DOUBLE RIDGED HORN ANTENNA	SAS-571	A.H.SYSTEM,INC	781	03, 11, 2021

Test Conditions
Temperature: 23,2 °C
Relative Humidity: 48,1 % R.H.

Frequency Range of Measurement
1 GHz to 6 GHz

Instrument Settings
IF Band Width: 1 MHz

Test Results
The requirements are:

- PASS
- NOT PASS
- NOT APPLICABLE

Remarks
See Appendix A for test data.

This report shall not be reproduced except in full, without the written approval of KES Co., Ltd.
The results shown in this test report refer only to the sample(s) tested unless otherwise stated.
The authenticity of the test report, contact shchoi@kes.co.kr



APPENDIX A – TEST DATA

Conducted Emissions at Mains Power Ports

HOT LINE

Common Information

Test Description:	Conducted Emission
Model No.:	XNP-6400RW
Phase:	-
Mode:	H
Operator Name:	KES

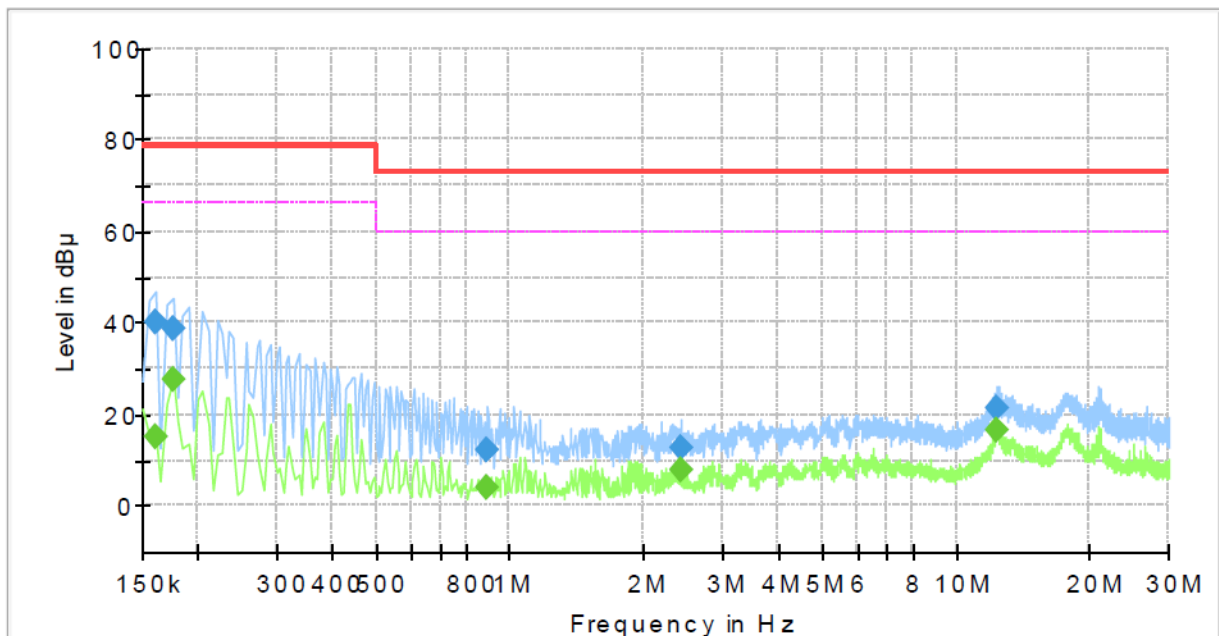

Final Result

Frequency (MHz)	QuasiPeak (dBµV)	CAverage (dBµV)	Limit (dBµV)	Margin (dB)	Meas. Time (ms)	Bandwidth (kHz)	Line	Corr. (dB)
0.160000	---	15.19	66.00	50.81	1000.0	9.000	L1	19.5
0.160000	40.31	---	79.00	38.69	1000.0	9.000	L1	19.5
0.175000	---	27.77	66.00	38.23	1000.0	9.000	L1	19.5
0.175000	38.83	---	79.00	40.17	1000.0	9.000	L1	19.5
0.890000	---	3.89	60.00	56.11	1000.0	9.000	L1	19.6
0.890000	12.23	---	73.00	60.77	1000.0	9.000	L1	19.6
2.425000	---	7.94	60.00	52.06	1000.0	9.000	L1	19.7
2.425000	12.64	---	73.00	60.36	1000.0	9.000	L1	19.7
12.310000	---	16.38	60.00	43.62	1000.0	9.000	L1	20.0
12.310000	21.38	---	73.00	51.62	1000.0	9.000	L1	20.0

This report shall not be reproduced except in full, without the written approval of KES Co., Ltd.
 The results shown in this test report refer only to the sample(s) tested unless otherwise stated.
 The authenticity of the test report, contact shchoi@kes.co.kr

NEUTRAL LINE

Common Information

Test Description:	Conducted Emission
Model No.:	XNP-6400RW
Phase:	-
Mode:	N
Operator Name:	KES

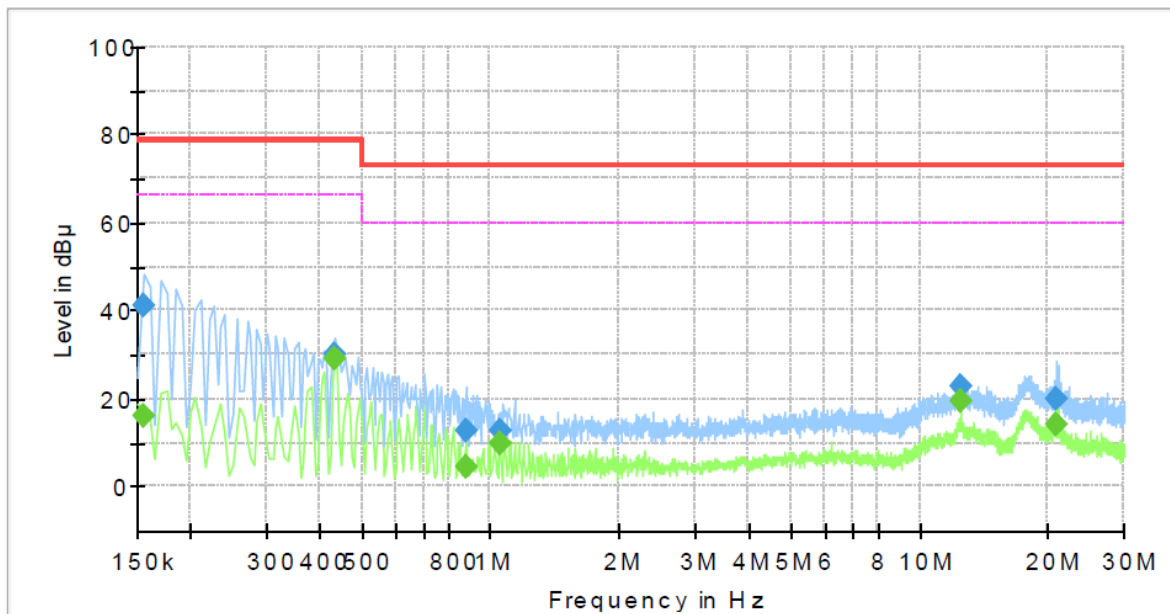

Final Result

Frequency (MHz)	QuasiPeak (dBμV)	CAverage (dBμV)	Limit (dBμV)	Margin (dB)	Meas. Time (ms)	Bandwidth (kHz)	Line	Corr. (dB)
0.155000	---	15.87	66.00	50.13	1000.0	9.000	N	19.5
0.155000	41.03	---	79.00	37.97	1000.0	9.000	N	19.5
0.435000	---	29.03	66.00	36.97	1000.0	9.000	N	19.6
0.435000	30.21	---	79.00	48.79	1000.0	9.000	N	19.6
0.880000	---	4.67	60.00	55.33	1000.0	9.000	N	19.6
0.880000	12.79	---	73.00	60.21	1000.0	9.000	N	19.6
1.050000	---	9.77	60.00	50.23	1000.0	9.000	N	19.7
1.050000	12.71	---	73.00	60.29	1000.0	9.000	N	19.7
12.500000	---	19.54	60.00	40.46	1000.0	9.000	N	20.1
12.500000	22.85	---	73.00	50.15	1000.0	9.000	N	20.1
20.905000	---	14.25	60.00	45.75	1000.0	9.000	N	20.3
20.905000	19.90	---	73.00	53.10	1000.0	9.000	N	20.3

◆ Calculation

QuasiPeak [dBuV] / CAverage [dBuV] = Reading Value [dBuV] + Corr. [dB]

QuasiPeak / CAverage : The Final Value

Reading Value : Not shown in the table.

Corr. : Correction values (LISN FACTOR + (Cable Loss + Pulse Limiter FACTOR))

This report shall not be reproduced except in full, without the written approval of KES Co., Ltd.

The results shown in this test report refer only to the sample(s) tested unless otherwise stated.

The authenticity of the test report, contact shchoi@kes.co.kr

Conducted Emissions at Telecommunication Ports [100 Mbps]

Common Information

Test Description:	Telecommunication Emission
Model No.:	XNP-6400RW
Mode :	
Speed :	100 Mbps
Operator Name:	KES

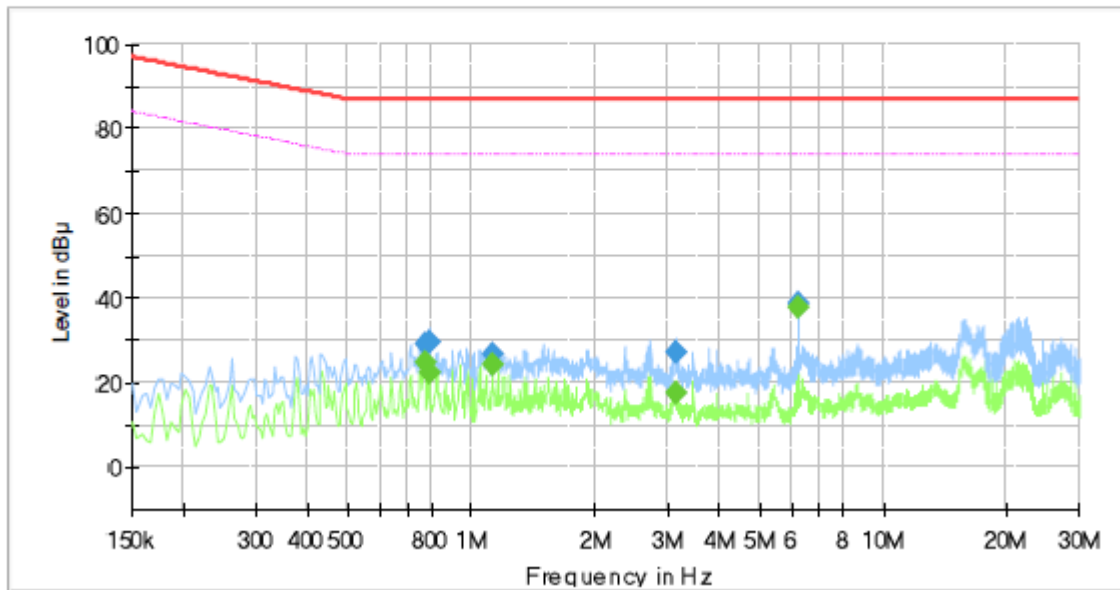

Final Result

Frequency (MHz)	QuasiPeak (dBµV)	CAverage (dBµV)	Limit (dBµV)	Margin (dB)	Meas. Time (ms)	Bandwidth (kHz)	Line	Corr. (dB)
0.770000	---	24.68	74.00	49.32	1000.0	9.000	Single Line	19.6
0.770000	29.02	---	87.00	57.98	1000.0	9.000	Single Line	19.6
0.790000	---	22.21	74.00	51.79	1000.0	9.000	Single Line	19.6
0.790000	29.79	---	87.00	57.21	1000.0	9.000	Single Line	19.6
1.126000	---	24.49	74.00	49.51	1000.0	9.000	Single Line	19.6
1.126000	26.62	---	87.00	60.38	1000.0	9.000	Single Line	19.6
3.146000	---	17.67	74.00	56.33	1000.0	9.000	Single Line	19.6
3.146000	27.17	---	87.00	59.83	1000.0	9.000	Single Line	19.6
6.250000	---	37.62	74.00	36.38	1000.0	9.000	Single Line	19.7
6.250000	38.61	---	87.00	48.39	1000.0	9.000	Single Line	19.7

◆ Calculation

QuasiPeak [dBuV] / CAverage [dBuV] = Reading Value [dBuV] + Corr. [dB]

QuasiPeak / CAverage : The Final Value

Reading Value : Not shown in the table.

Corr. : Correction values (ISN FACTOR + (Cable Loss + Pulse Limiter FACTOR))

This report shall not be reproduced except in full, without the written approval of KES Co., Ltd.
The results shown in this test report refer only to the sample(s) tested unless otherwise stated.
The authenticity of the test report, contact shchoi@kes.co.kr



Radiated Electric Field Emissions(Below 1 GHz)

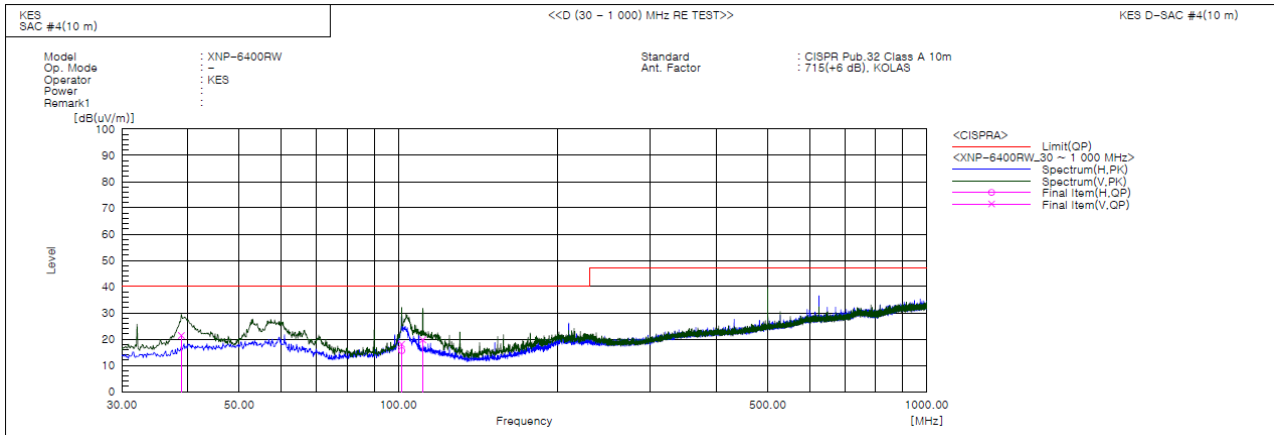

Final Result

No.	Frequency [MHz]	(P)	Reading QP [dB(uV)]	c.f [dB(1/m)]	Result QP [dB(uV/m)]	Limit QP [dB(uV/m)]	Margin QP [dB]	Height [cm]	Angle [deg]	Remark
1	38.851	V	45.0	-23.6	21.4	40.0	18.6	100.0	292.0	
2	101.536	V	40.7	-22.6	18.1	40.0	21.9	138.0	129.0	
3	101.538	H	38.2	-22.6	15.6	40.0	24.4	314.0	104.0	
4	111.238	V	42.6	-22.9	19.7	40.0	20.3	108.0	134.0	

◆ Calculation

$$\text{Result(QP) [dB(}\mu\text{V/m)]} = (\text{Reading(QP) [dB(}\mu\text{V)]} + \text{c.f [dB(1/m)]})$$

$$\text{Margin(OP) [dB]} = \text{Limit [dB(}\mu\text{V/m)]} - \text{Result(OP) [dB(}\mu\text{V/m)]}$$

Reading(OP) : Reading value, Result(OP) : Reading value + Factor value

Limit(OP) : Limit value, c.f : (ANT Factor + Cable Loss - Preamp Factor), Margin: Margin value

This report shall not be reproduced except in full, without the written approval of KES Co., Ltd.
The results shown in this test report refer only to the sample(s) tested unless otherwise stated.
The authenticity of the test report, contact shchoi@kes.co.kr



Radiated Electric Field Emissions(Above 1 GHz)

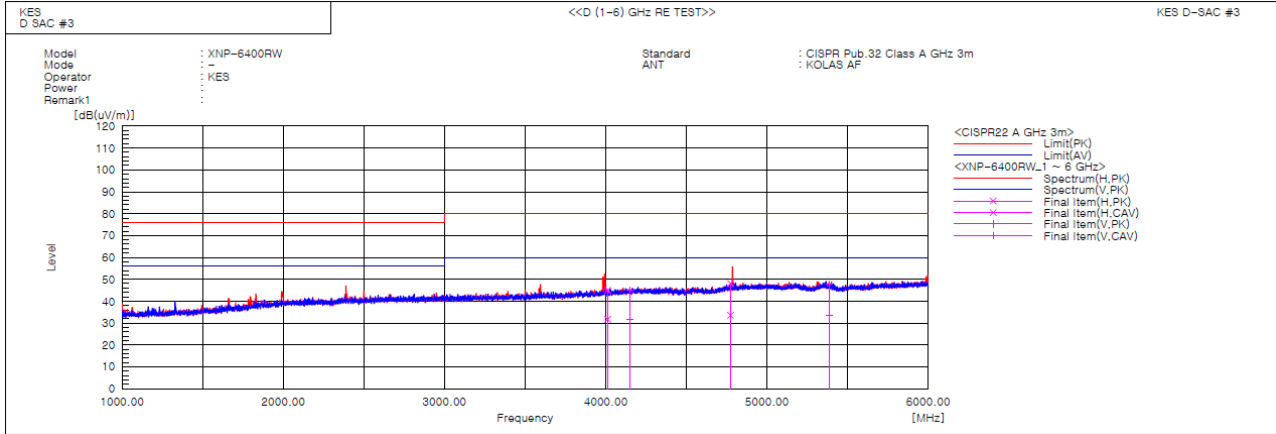

Final Result

No.	Frequency [MHz]	(P)	Reading PK [dB(uV)]	Reading CAV [dB(uV)]	c.f [dB(1/m)]	Result PK [dB(uV/m)]	Result CAV [dB(uV/m)]	Limit PK [dB(uV/m)]	Limit AV [dB(uV/m)]	Margin PK [dB]	Margin CAV [dB]	Height [cm]	Angle [deg]	Remark
1	4011.147	H	40.2	26.9	4.8	45.0	31.7	80.0	60.0	35.0	28.3	100.0	152.6	
2	4147.764	V	39.5	26.1	5.6	45.1	31.7	80.0	60.0	34.9	28.3	100.0	146.1	
3	4773.402	H	40.7	26.1	7.5	48.2	33.6	80.0	60.0	31.8	26.4	100.0	36.9	
4	5383.777	V	39.4	25.3	8.4	47.8	33.7	80.0	60.0	32.2	26.3	100.0	150.4	

◆ Calculation

$$\text{Result(PK/CAV)} \text{ [dB}(\mu\text{V/m)}] = (\text{Reading(PK/CAV)} \text{ [dB}(\mu\text{V)}] + \text{c.f} \text{ [dB(1/m)}])$$

$$\text{Margin(PK/CAV)} \text{ [dB]} = \text{Limit} \text{ [dB}(\mu\text{V/m)}] - \text{Result(PK/CAV)} \text{ [dB}(\mu\text{V/m)}]$$

Reading(PK/CAV) : Reading value, Result(PK/CAV) : Reading value + Factor value

Limit(QP) : Limit value, c.f : (ANT Factor + Cable Loss - Preamp Factor), Margin: Margin value

This report shall not be reproduced except in full, without the written approval of KES Co., Ltd.
 The results shown in this test report refer only to the sample(s) tested unless otherwise stated.
 The authenticity of the test report, contact shchoi@kes.co.kr

Test Setup Photos and Configuration Conducted Emissions at Mains Power Ports



This report shall not be reproduced except in full, without the written approval of KES Co., Ltd.
The results shown in this test report refer only to the sample(s) tested unless otherwise stated.
The authenticity of the test report, contact shchoi@kes.co.kr

Conducted Emissions at Telecommunication Ports



This report shall not be reproduced except in full, without the written approval of KES Co., Ltd.
The results shown in this test report refer only to the sample(s) tested unless otherwise stated.
The authenticity of the test report, contact shchoi@kes.co.kr

Radiated Electric Field Emissions(Below 1 GHz)



This report shall not be reproduced except in full, without the written approval of KES Co., Ltd.
The results shown in this test report refer only to the sample(s) tested unless otherwise stated.
The authenticity of the test report, contact shchoi@kes.co.kr

Radiated Electric Field Emissions(Above 1 GHz)



This report shall not be reproduced except in full, without the written approval of KES Co., Ltd.
The results shown in this test report refer only to the sample(s) tested unless otherwise stated.
The authenticity of the test report, contact shchoi@kes.co.kr

EUT External Photographs

(Top)



(Bottom)



This report shall not be reproduced except in full, without the written approval of KES Co., Ltd.
The results shown in this test report refer only to the sample(s) tested unless otherwise stated.
The authenticity of the test report, contact shchoi@kes.co.kr

EUT Internal Photographs

(Internal View)



This report shall not be reproduced except in full, without the written approval of KES Co., Ltd.
The results shown in this test report refer only to the sample(s) tested unless otherwise stated.
The authenticity of the test report, contact shchoi@kes.co.kr

EUT Internal View – DRIVE Board

(Top)

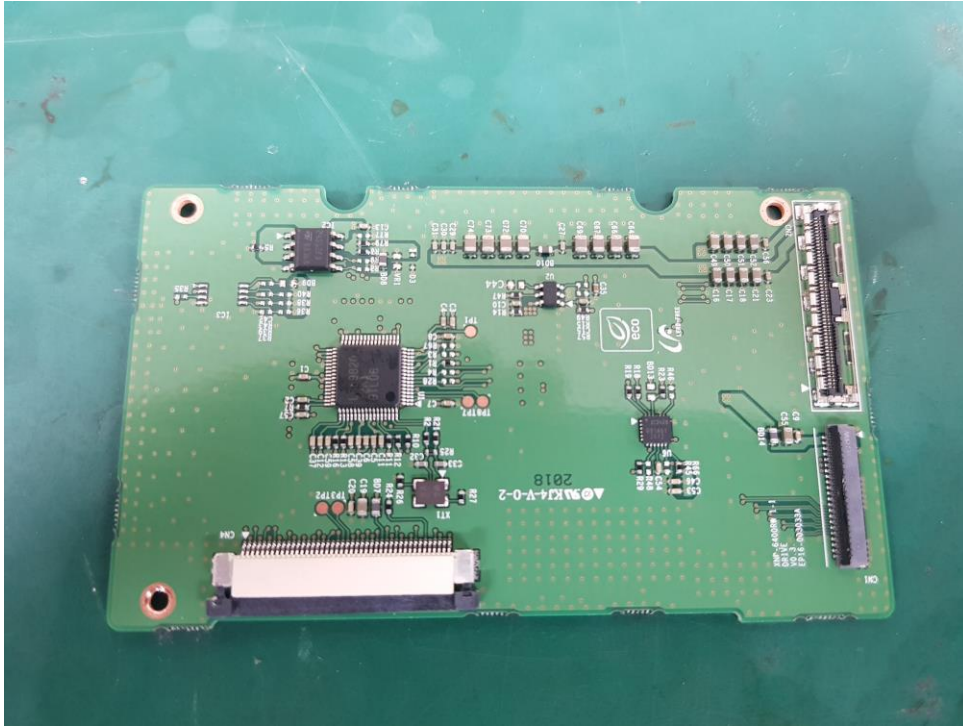

(Bottom)

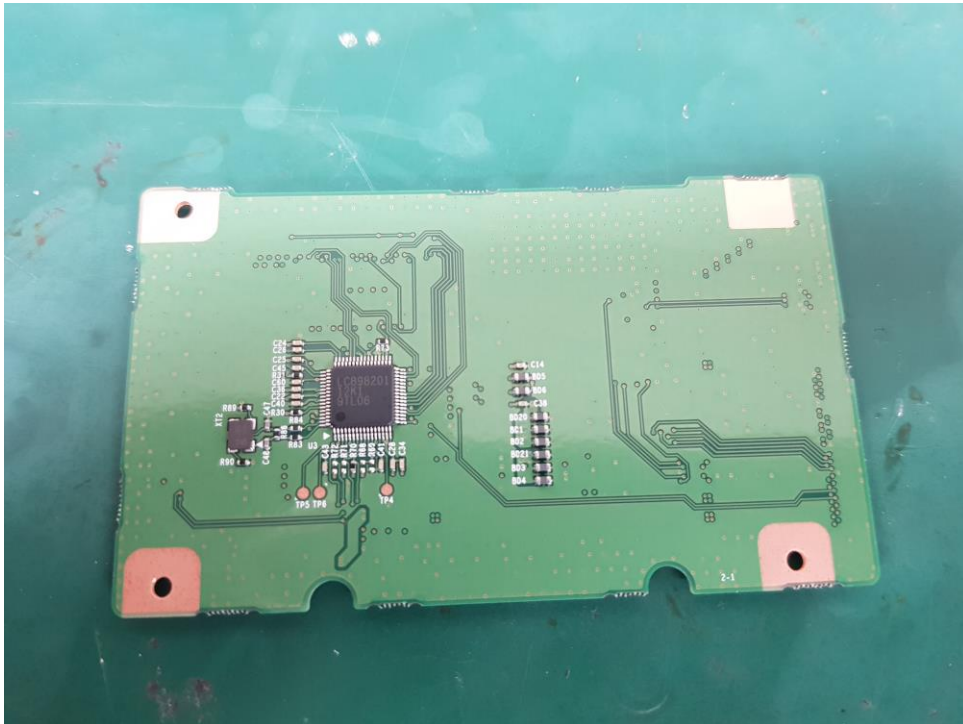

This report shall not be reproduced except in full, without the written approval of KES Co., Ltd.
The results shown in this test report refer only to the sample(s) tested unless otherwise stated.
The authenticity of the test report, contact shchoi@kes.co.kr

EUT Internal View – HALL Board

(Top)



(Bottom)

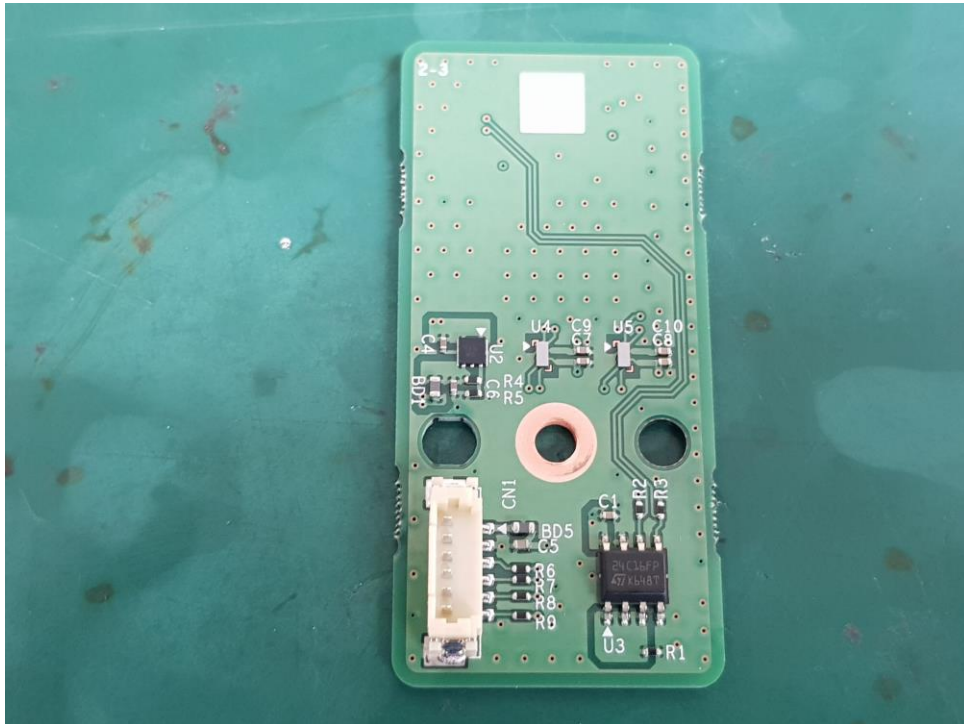

This report shall not be reproduced except in full, without the written approval of KES Co., Ltd.
The results shown in this test report refer only to the sample(s) tested unless otherwise stated.
The authenticity of the test report, contact shchoi@kes.co.kr

EUT Internal View – IR-LED LEFT Board

(Top)

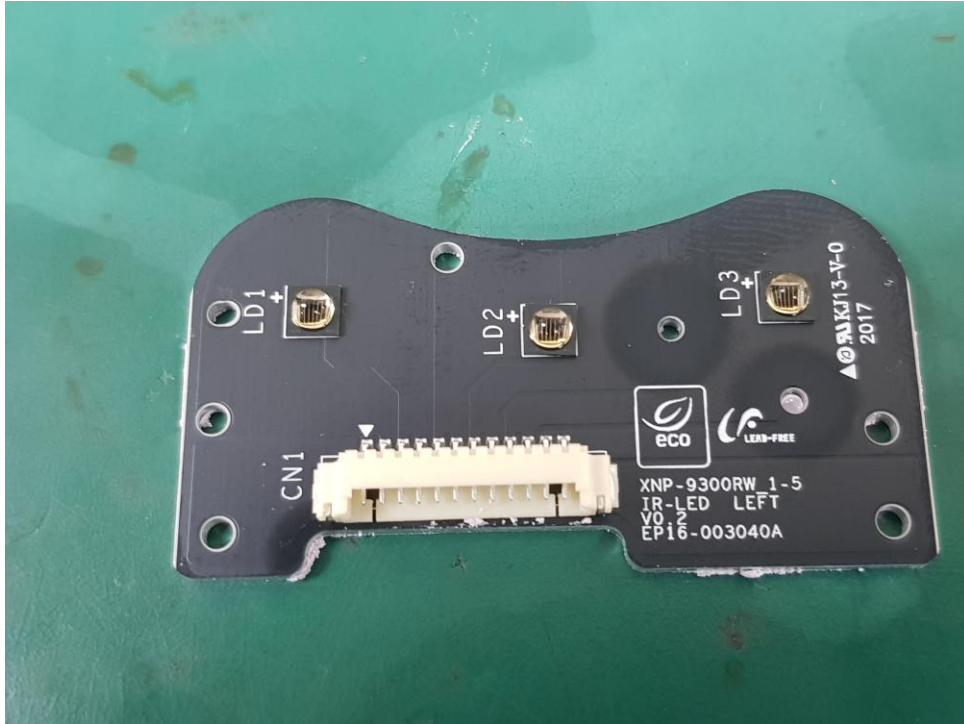

(Bottom)

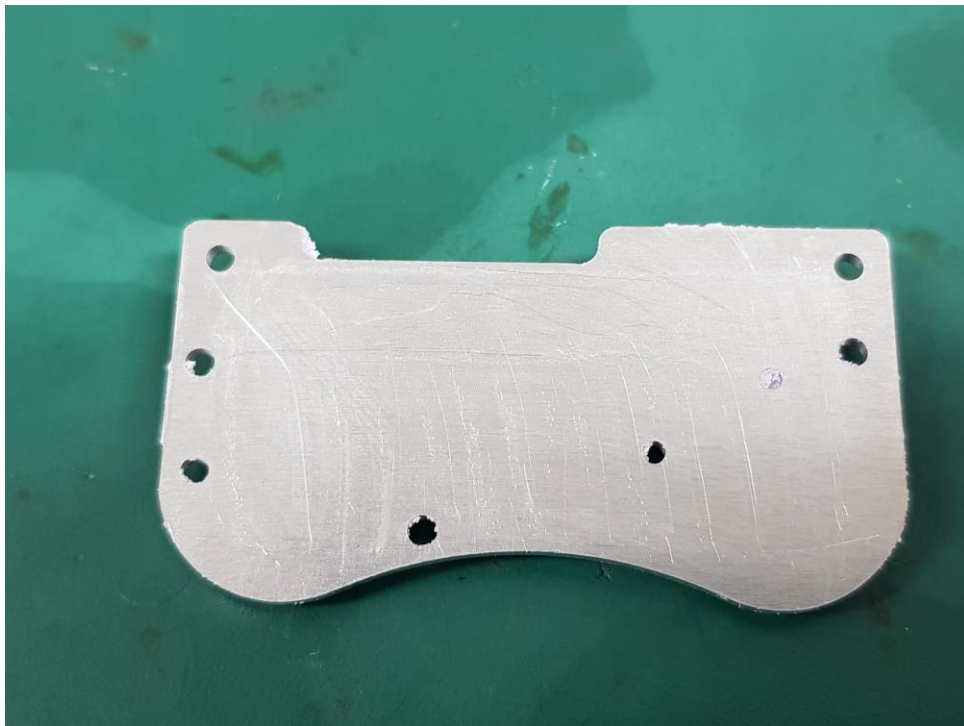

This report shall not be reproduced except in full, without the written approval of KES Co., Ltd.
The results shown in this test report refer only to the sample(s) tested unless otherwise stated.
The authenticity of the test report, contact shchoi@kes.co.kr

EUT Internal View – IR-LED RIGHT Board

(Top)

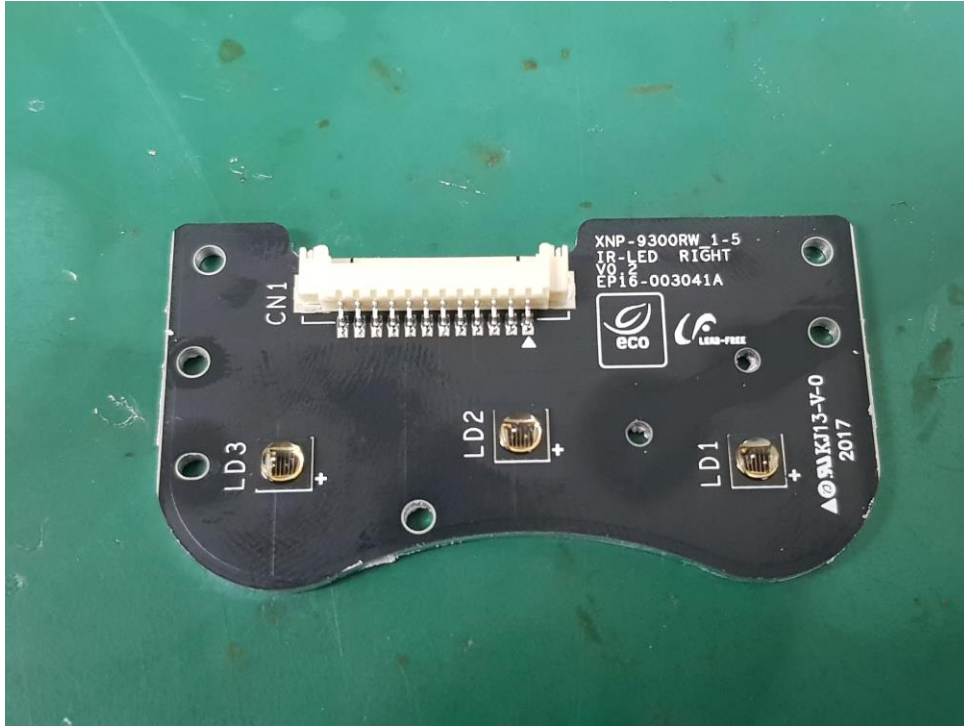

(Bottom)



This report shall not be reproduced except in full, without the written approval of KES Co., Ltd.
The results shown in this test report refer only to the sample(s) tested unless otherwise stated.
The authenticity of the test report, contact shchoi@kes.co.kr

EUT Internal View – MOTION Board

(Top)

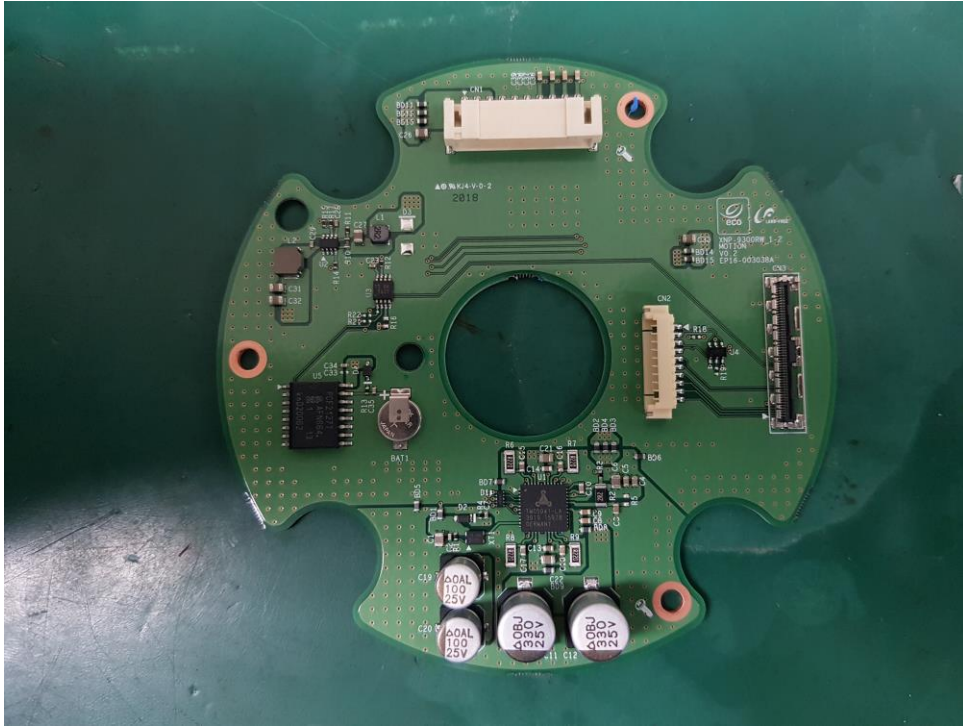

(Bottom)



This report shall not be reproduced except in full, without the written approval of KES Co., Ltd.
The results shown in this test report refer only to the sample(s) tested unless otherwise stated.
The authenticity of the test report, contact shchoi@kes.co.kr

EUT Internal View – NETWORK Board

(Top)

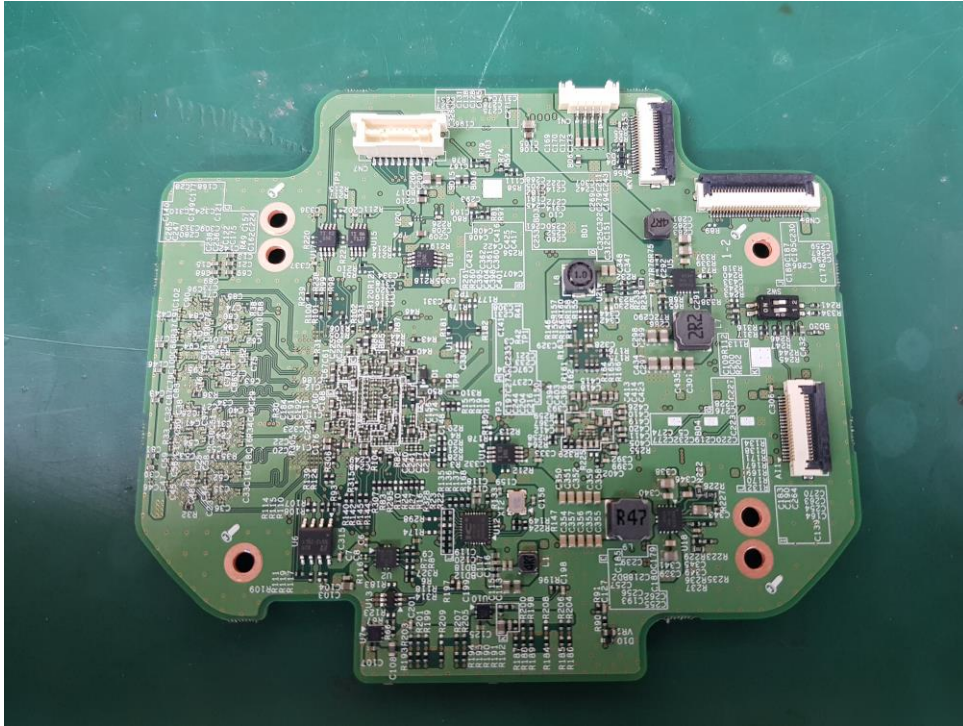

(Bottom)

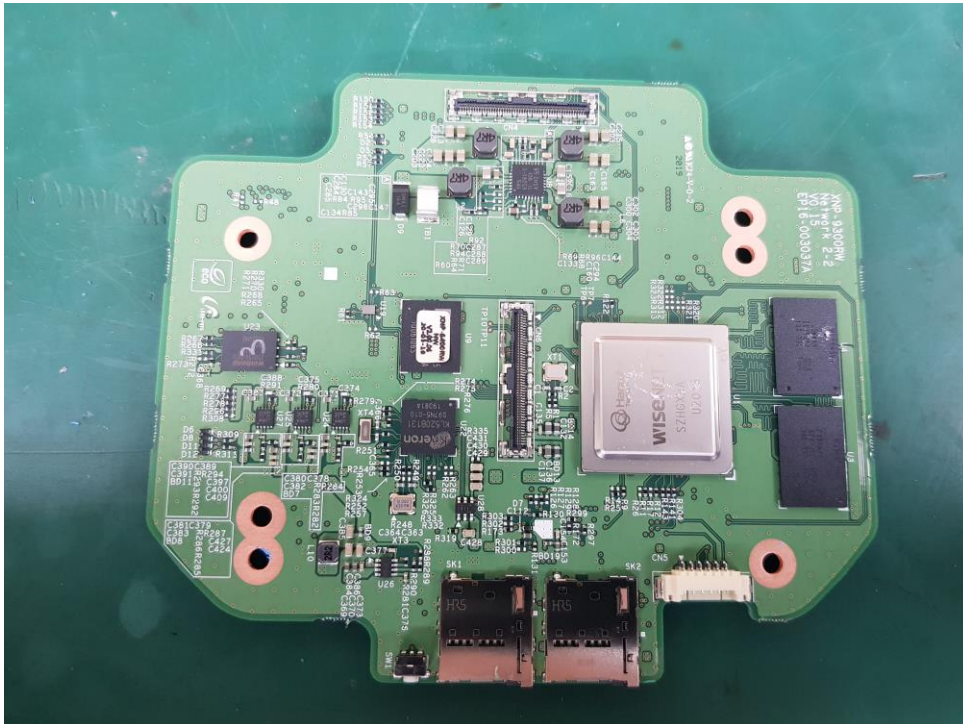

This report shall not be reproduced except in full, without the written approval of KES Co., Ltd.
The results shown in this test report refer only to the sample(s) tested unless otherwise stated.
The authenticity of the test report, contact shchoi@kes.co.kr

EUT Internal View – SENSOR Board

(Top)

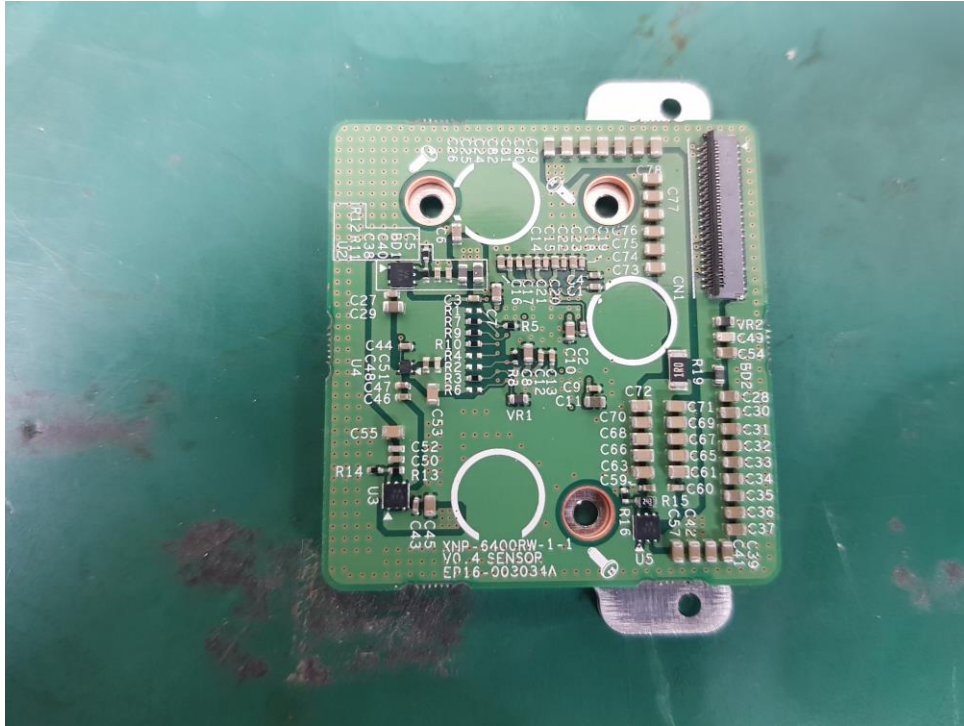

(Bottom)

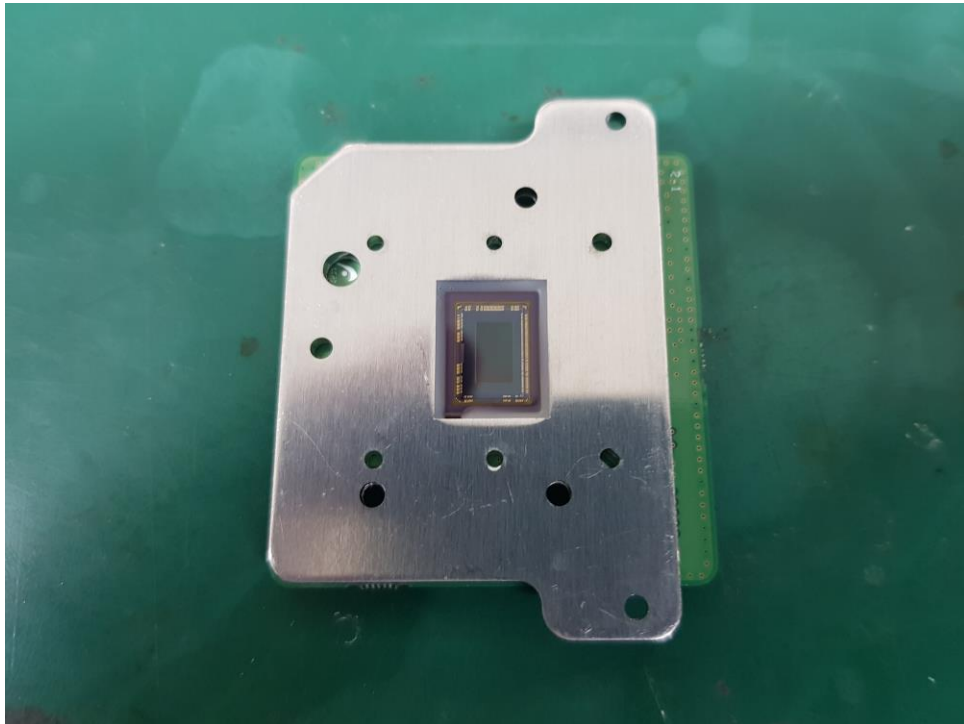

This report shall not be reproduced except in full, without the written approval of KES Co., Ltd.
The results shown in this test report refer only to the sample(s) tested unless otherwise stated.
The authenticity of the test report, contact shchoi@kes.co.kr

EUT Internal View – WIPER Board

(Top)

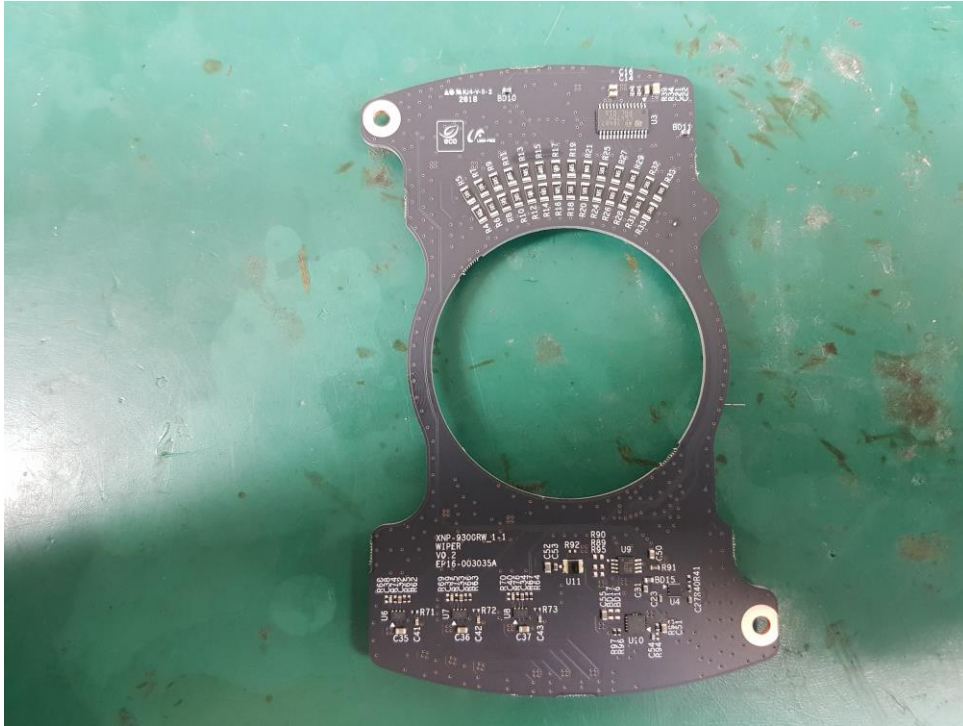

(Bottom)



This report shall not be reproduced except in full, without the written approval of KES Co., Ltd.
The results shown in this test report refer only to the sample(s) tested unless otherwise stated.
The authenticity of the test report, contact shchoi@kes.co.kr

EUT Internal View – LENS

(Top)



(Bottom)

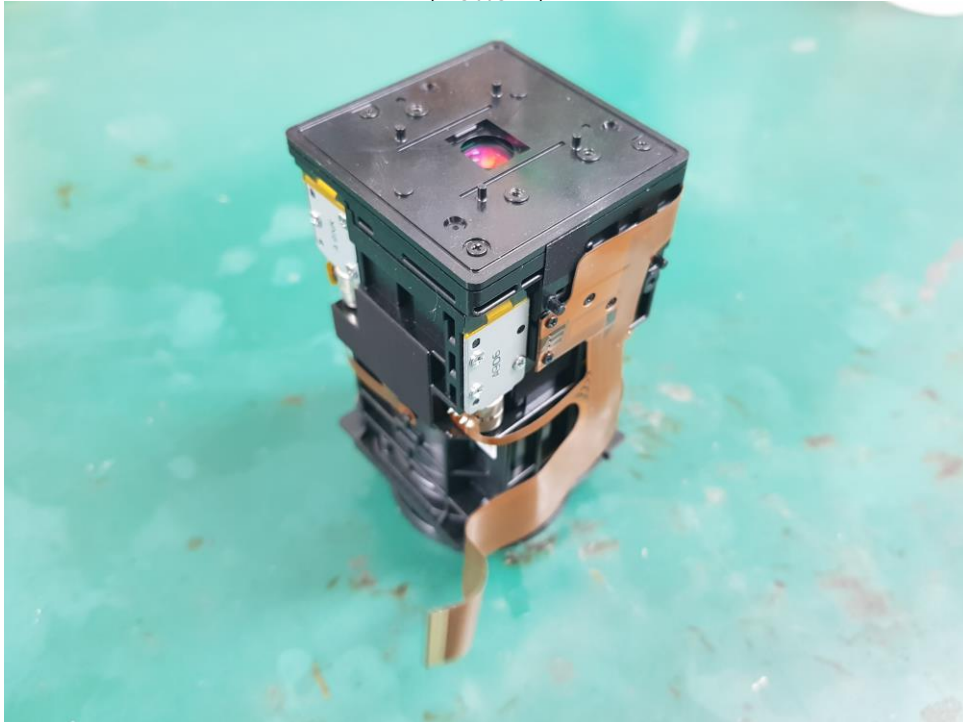

This report shall not be reproduced except in full, without the written approval of KES Co., Ltd.
The results shown in this test report refer only to the sample(s) tested unless otherwise stated.
The authenticity of the test report, contact shchoi@kes.co.kr

EUT Internal View – Fiber PoE Injector

(Top)

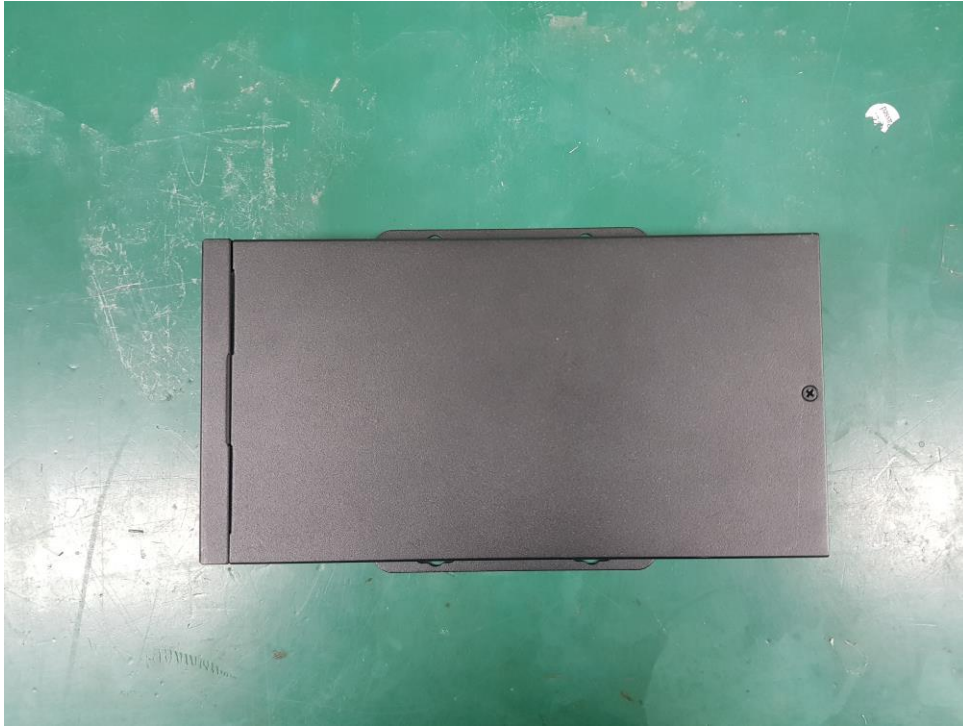

(Bottom)



This report shall not be reproduced except in full, without the written approval of KES Co., Ltd.
The results shown in this test report refer only to the sample(s) tested unless otherwise stated.
The authenticity of the test report, contact shchoi@kes.co.kr